

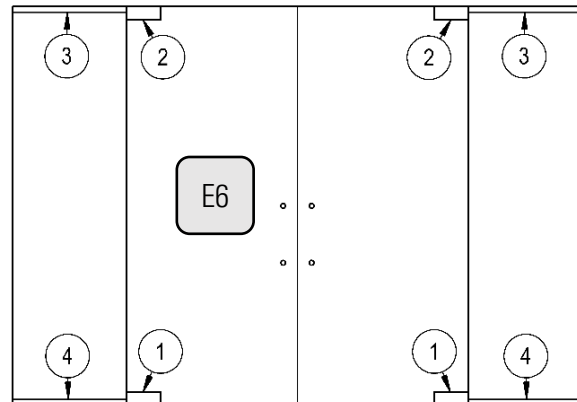

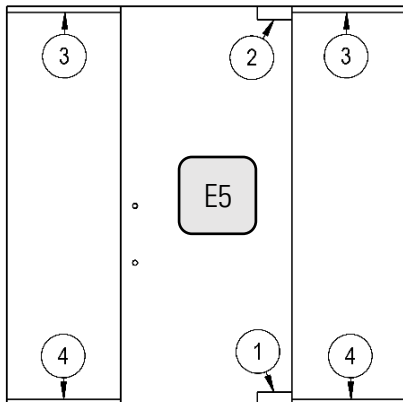

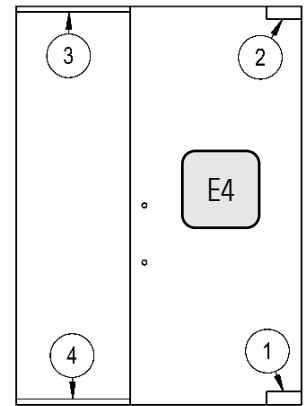

Elevation	Description
E1	Single Door
E2	Double Doors
E3	Single Door with Hinge-Side Sidelite
E4	Single Door with Strike-Side Sidelite
E5	Single Door with Double Sidelites
E6	Double Doors with Double Sidelites

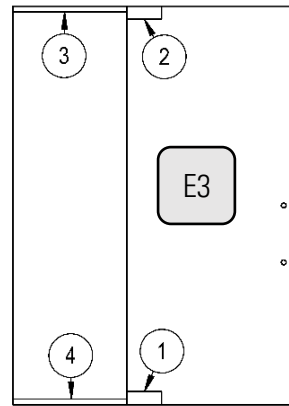
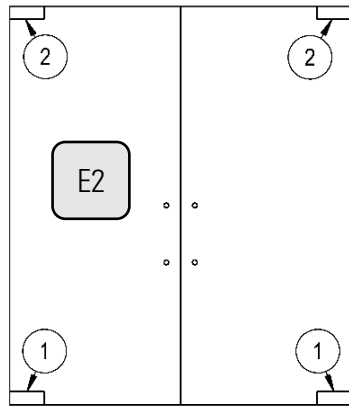
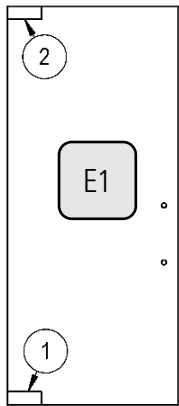

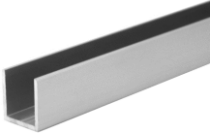
		Description:	<h2 style="text-align: center;">ALVA ELEVATIONS E1-E6</h2>
Bohle America Inc 10924 Granite Street, Suite 200 Charlotte, NC 28273	T +1 888 838 6006 F +1 704 547 8420 info@bohle-america.com		





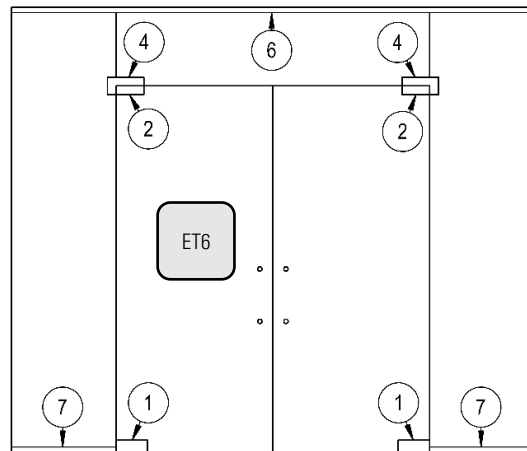
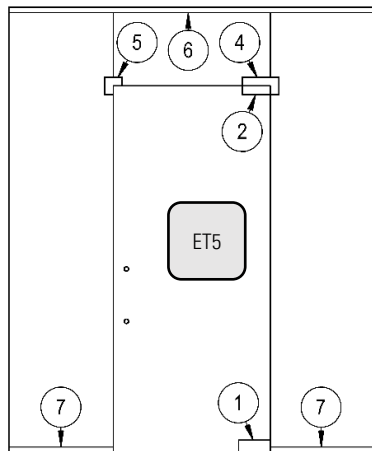
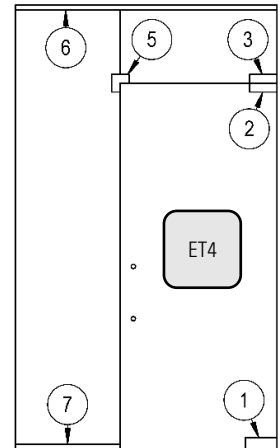
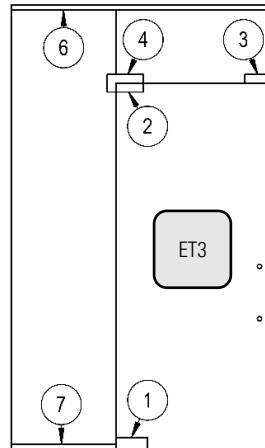
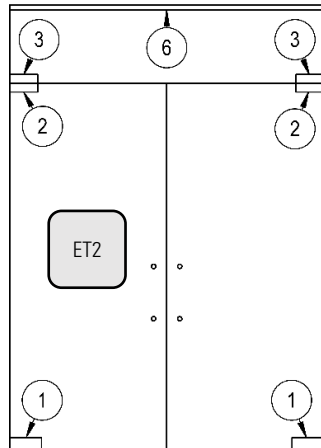
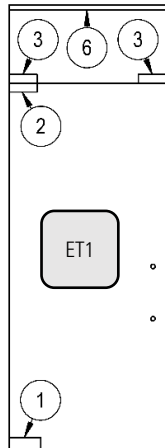

#	Item	Item Quantity x Elevation					
		E1	E2	E3	E4	E5	E6
1	Self-Closing Bottom Patch 	1	2	1	1	1	2
2	PT20 PLUS Top Patch & PT24 Pivot 	1	2	1	1	1	2
3	1-Piece Top Channel - 94" 	-	-	1	1	2	2
4	2-Piece Bottom Channel - 94" 	-	-	1	1	2	2
-	Channel Gasket for 1/2" Glass - 196" 	-	-	2	2	4	4



		Description:	ALVA ELEVATIONS E1-E6
Bohle America Inc 10924 Granite Street, Suite 200 Charlotte, NC 28273	T +1 888 838 6006 F +1 704 547 8420 info@bohle-america.com		

Elevation	Description
ET1	Single Door with Transom
ET2	Double Doors with Transom
ET3	Single Door with Transom & Hinge-Side Sidelite
ET4	Single Door with Transom & Strike-Side Sidelite
ET5	Single Door with Transom & Double Sidelites
ET6	Double Doors with Transom & Double Sidelites

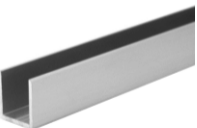

		<p>Description:</p> <p style="text-align: center;">ALVA ELEVATIONS ET1-ET6</p>
<p>Bohle America Inc 10924 Granite Street, Suite 200 Charlotte, NC 28273</p>	<p>T +1 888 838 6006 F +1 704 547 8420 info@bohle-america.com</p>	

#	Item	Item Quantity x Elevation						
		ET1	ET2	ET3	ET4	ET5	ET6	
1	Self-Closing Bottom Patch		1	2	1	1	1	2
2	PT20 Top Patch for Transoms		1	2	1	1	1	2
3	PT30.3 Transom-Wall Patch with Pivot		2	2	1	1	-	-
4	PT40 Transom-Sidelite Patch with Pivot		-	-	1	-	1	2
5	PT60 Transom-Sidelite Patch		-	-	-	1	1	-
6	1-Piece Top Channel - 94"		1	1	1	1	2	3
7	2-Piece Bottom Channel - 94"		-	-	1	1	2	2
-	Channel Gasket for 1/2" Glass - 196"		1	1	2	2	4	5

		Description:	ALVA ELEVATIONS ET1-ET6
Bohle America Inc 10924 Granite Street, Suite 200 Charlotte, NC 28273	T +1 888 838 6006 F +1 704 547 8420 info@bohle-america.com		